



E-Bike components

User manual

Rear motor system:

- R250HP-SPM148-E25 rear motor
- BB sensor
- OLED display (mph)
- Battery: Lithium ion type

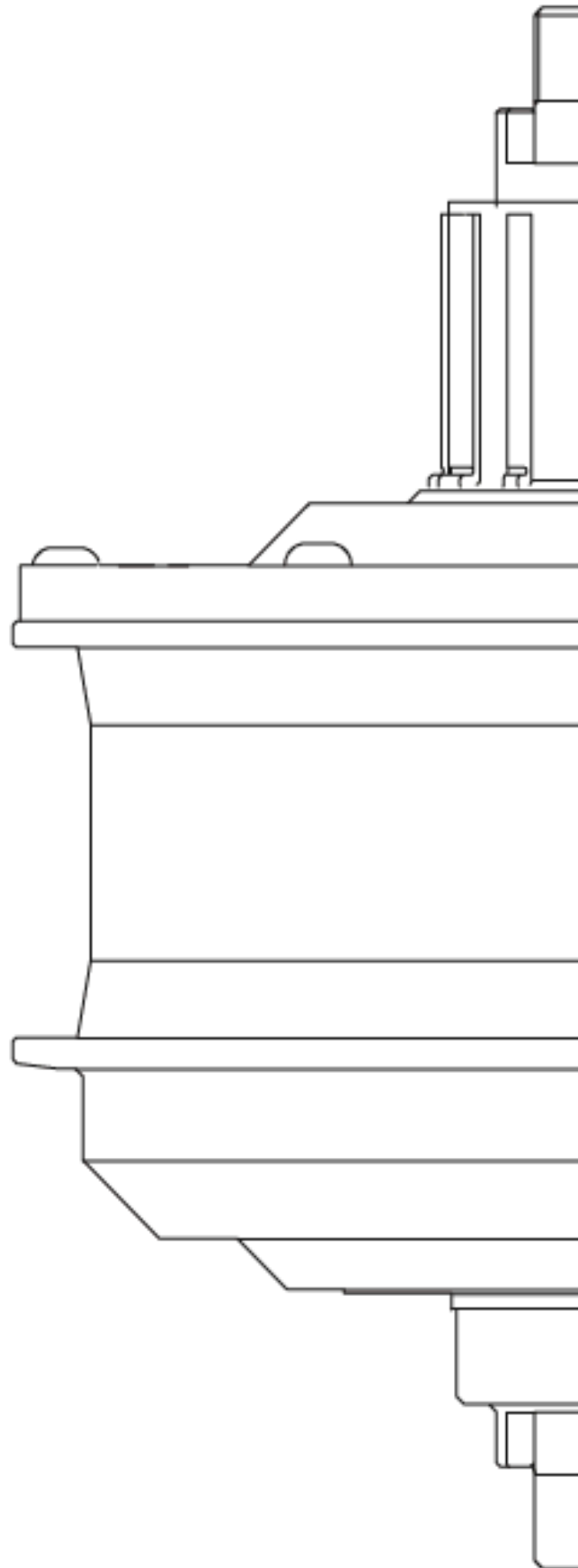

Important information

- Contact the dealer where the bike was purchased for the information of installation and adjustment of the products that are not found in the user manual.
- Do not dis-assemble or alter the products.
- Use the products according to the local laws and regulations.

For safety reason, make sure to read this user manual thoroughly before using the system.

Important safety information

In case if any parts need to be replaced, contact a dealer or the place where the bike was purchased.

Make sure to observe the following notice in order to avoid burns or injury from fluid leakage, overheating, fire or explosions.

Making sure for Safety



Handling the battery

- Do not deform, modify, disassemble or apply solder directly to the battery. It may cause leakage, overheating, bursting or ignition of battery if it's not followed.
- Do not leave the battery near sources of heat such as heaters or fire. Do not heat the battery or throw it into a fire. It may cause bursting of ignition or the battery if it's not followed.
- Do not put the battery in the condition such as strong shock or throw it. If this is not observed, overheating, bursting or fire may occur.
- Do not place the battery into fresh water or sea/salt water and do not allow the battery terminals/connectors to get wet. It may cause overheating, bursting or ignition of the battery if it's not followed.

- Use the SR SUNTOUR specified charger and observe the specified charging conditions when charging the specified battery. It may cause overheating, bursting or ignition of the battery if it's not followed.



How to ride more safely

- While riding,, do not focus too much attention on the display, as this can lead to accidents.
- Make sure that the wheels are securely attached to the bike before start riding. If the wheels are not securely attached, the bike may fall over, causing severe damage and possible serious injury.
- When riding a power-assisted bike, make sure that you are completely familiar with the starting characteristics of the bike before riding it on roads with several vehicles lanes and pedestrian footpaths. If the bike starts off suddenly, accidents may result.
- Check to see if the lights are properly working when riding at night.

Using the product safely

- Be sure to remove the battery before performing wiring or installation work on the bike. Otherwise there is a danger of electric shock.
- When charging the battery while it is mounted on the bike, do not move the bike. The power plug of the battery charger may come loose and not be fully inserted into the electric outlet, resulting to the risk of fire.
- When installing this product, make sure to follow the instructions given in the user manual. It is also recommended that the genuine SR SUNTOUR parts are only used at such times. If nuts and bolts are left loosened or the products are damaged, the bike may fall over suddenly and cause serious injury.
- Do not disassemble the product. Disassembling may cause injury to persons.
- After reading the user manual carefully, keep it in a safe place for later reference.

How to handle the battery

- In case if any liquid leaking from the battery gets into your eyes, wash the affected area immediately and clean thoroughly with clean water without rubbing your eyes, and consult the medical advice immediately. If this is not done, the battery liquid may damage your eyes.
- Do not recharge the battery in places with high humidity or out-doors. It may result in electric shock if it's not followed.
- Do not insert or remove the plug while it is wet. If it is not observed, electric shocks may occur. If there is water leaking out of the plug, dry it thoroughly before inserting it.
- If the battery doesn't become fully charged after 6 hours of charging, un-plug the battery from the outlet immediately to stop charging, then contact the place of purchase. It may cause the overheating, bursting or ignition of the battery if it's not followed.
- Do not use the battery if there is any scratches or other external damage found visibly. It may cause overheating, bursting or problems with operation.
- The operating temperature ranges for the battery are shown as below. Do not use the battery in temperatures outside these ranges. If the battery is used or stored in temperatures outside these ranges, it may cause fire, injury or problems with operation.

1) During discharging:

-10°C - 50 °C / 15°F - 120 °F

2) During charging:

0°C - 40 °C / 30°F - 105 °F



CAUTION

To be sure the safe riding

- Make sure to follow the instructions in the user manual for the bike, in order to ride safely.

Using the products safely

- Make sure to check the battery charger and adaptor time to time, especially the cable, plug, and case for any damage. If the charger or adaptor is broken, do not use it until it has been repaired.
- This product is not intended for use by persons (including children) with reduced physical, sensory or mental capabilities, or lack of experience and knowledge, unless they have been given supervision or instruction concerning use of the product by a person responsible for the safety.
- Do not allow children to play near the product.

How to handle the battery

- Do not leave the battery in a place exposed to direct sunlight, inside a vehicle on a hot day, or other hot places. This may result in battery leakage.
- In case of any leaked fluid gets on your skin or clothes, wash it off immediately with clean water. The leaked fluid may damage your skin.
- Store the battery in a safe place out of the reach of infants and pets.
- In case of any malfunctions or other problems occur, contact the place of purchase.
- Never attempt to modify the system by yourself, as it may cause problems with system operation.

NOTE

Using the product safely

- For installing or adjusting of product, consult a dealer.
- The product is designed to be waterproof to withstand wet weather riding conditions. However, do not place them into water deliberately.
- Do not clean the bike in a high-pressure wash. If water gets into any of the components, operating problem or rusting may result.
- Do not turn the bike upside down. The display or the remote switch may get damaged.
- Take the product carefully and avoid subjecting it to any strong shocks.
- Although the bike still functions as a regular bike even when the battery is removed, the light does not turn on if it is connected to the electric power system. Be aware that using the bike under these conditions will be considered non-observance of the road traffic laws in some countries.
- When charging the battery while it is mounted on the bike, be careful with below points.
 - ✓ When charging, make sure that there is no water on the charging port or the charger plug.
 - ✓ Ensure that the battery is locked into the battery mount before charging.
 - ✓ Do not remove the battery from the battery mount while charging.
 - ✓ Do not ride with the charger mounted.
 - ✓ Close the charging port cap when not charging.

How to handle the battery

- When carrying the power-assisted bike in a car, remove the battery from the bike and place the bike on a stable surface in the car.
- Before connecting the battery, make sure that there is no water or dirt in the connector where the battery will be connected.
- It is recommended to use s genuine SR SUNTOUR battery. If using a battery from another manufacturer, make sure to carefully read the instruction manual for the battery before use.

Battery key

- The number which can be found on the battery key is necessary when purchasing spare keys. Keep it in a safe place. There is a space to enter the key number inside of this user manual. Enter the key number for safely and later reference.

Disposal information of battery

When disposing the battery, follow the local regulations. If you are not sure, consult the place or purchase or a bike dealer.

Cleaning

- Do not use thinner or other solvents to clean any of the products. As such substances may damage the surfaces.
- Wash the chainrings time to time in a neutral detergent. In addition, cleaning the chain with neutral detergent and lubricating it can be an effective way of extending the useful life of the chainring and the chain.
- Use a wet cloth, with the water well wrung out, when cleaning the battery and/or plastic cover.
- For any questions regarding handling and maintenance, contact the place of purchase.
- Products are not guaranteed against natural wear and deterioration from normal use and aging.

HESC system overview

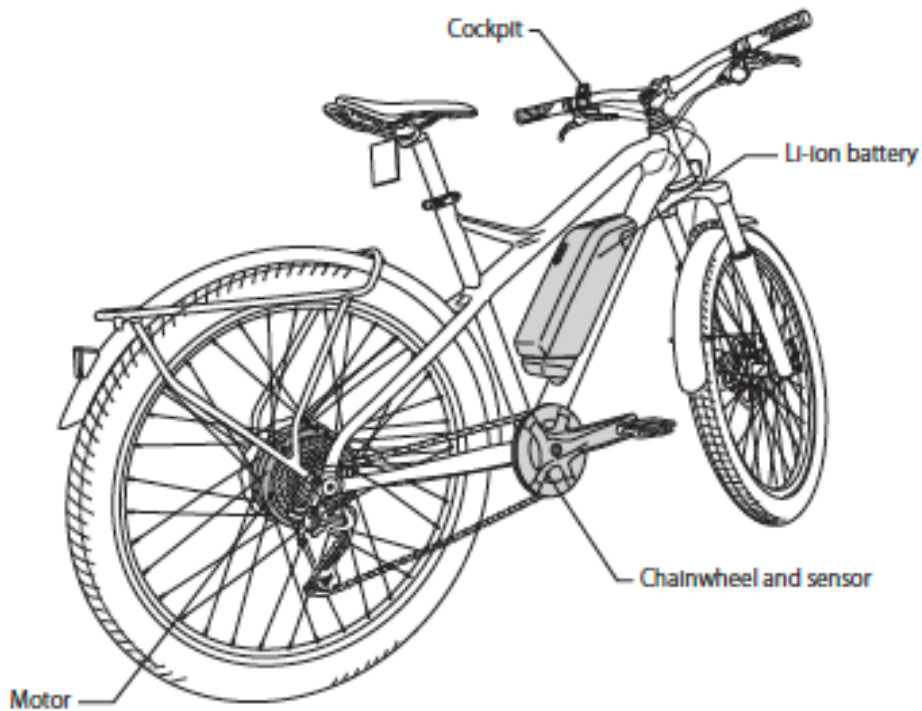

Operating temperature range during discharge	-10°C - 50 °C / 15°F - 120 °F
Operating temperature range during charge	10°C - 40 °C / 50°F - 105 °F
Storage temperature (battery)	-10°C - 30 °C / 15°F - 90 °F
Humidity (storage)	5 - 90%
Charging voltage	100V - 240VAC
Charging time	Approx. 7 hours for 12Ah pack Approx. 5 hours for 09 Ah pack
Battery type	Li-ion battery
Capacity	11600mAh (417.6Wh) 8700mAh (313.2Wh)
Nominal voltage	36VDC
Motor type	Rear wheel drive
Motor type	Brushless DC motor
Nominal motor power	250W
Maximum motor power	400W
Torque	60Nm

Charging the battery

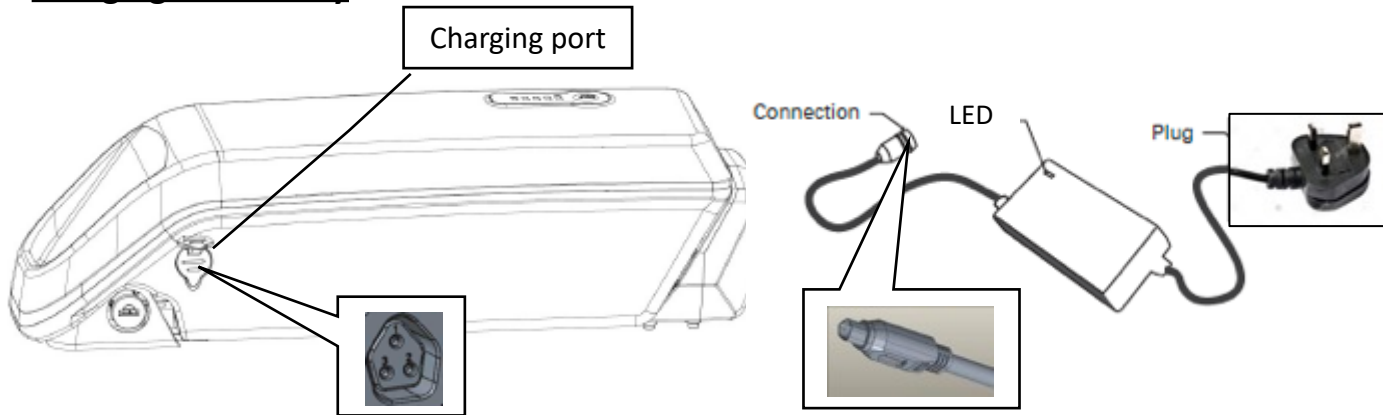

For safety this high energy density lithium-ion battery contains a sophisticated battery management system (BMS). The BMS ensures safe charging and discharge, continuously monitoring each of the cells in the battery individually. If the current drawn gets too high or the temperature of the battery is elevated, the BMS will shut the battery down for safety.

If the battery shuts down there are two levels of reset, it may come back on after a press of the power button on the battery. However if this does not reset you will have to remove the battery from the bike for a few seconds before refitting it.

- ◆ If the E-Bike is not in use, remove the battery and store it at a temperature between 0°C and 35°C in a dry environment.
- ◆ Do not store the battery with low capacity for a longer period.
- ◆ For long term storage, the battery should have a capacity of at least 40%.
- ◆ It is recommended to always discharge the battery completely and then fully charge it.

! WARNING

- Use batteries and chargers only from SR SUNTOUR with your bike. Use of other battery packs can cause injury and involve a risk of fire. If you use other battery packs, we will assume no liability or warranties.
- The battery must not be charged or stored in direct sunlight or in the vicinity of high temperatures.
- Avoid to contact with metal objects (paper clips, coins, keys, nails, screws, or other small metal objects, as this may cause a short circuit. Shorts caused in this way will invalidate any warranty claims.
- Do not open the battery pack. This could cause a short circuit. Opening of the battery package will invalidate any warranty claims.
- Do not connect or disconnect the battery pack/charger with wet hands.
- Keep the battery/charger out of reach of children and animals.
- Do not subject the battery or the charger to physical shocks, e.g., by dropping. If fluid gets in your eyes, seek medical advice. Fluid that leaks from the battery pack may cause skin irritation or burns.
- Do not bend the charging cable. The cable must not be rolled up while charging.
- The charger can be hot. Do not wrap cable around the charger and place it on floor coverings such as carpets, etc.
- If the battery is not fully charged after six hours, disconnect it immediately from the output to stop the charging process and contact your place of purchase. This can lead to overheating, bursting, or ignition of the battery.

When charging the battery alone

Step 1

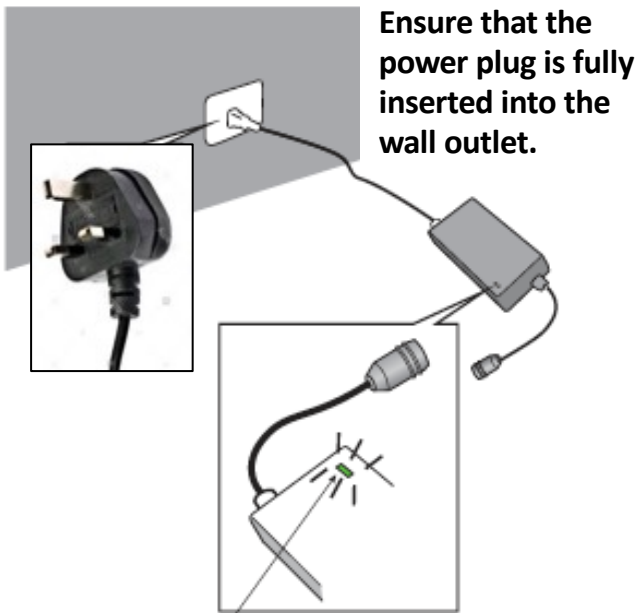

GREEN

The charger LED will change to green when the battery is fully charged.

Step 2

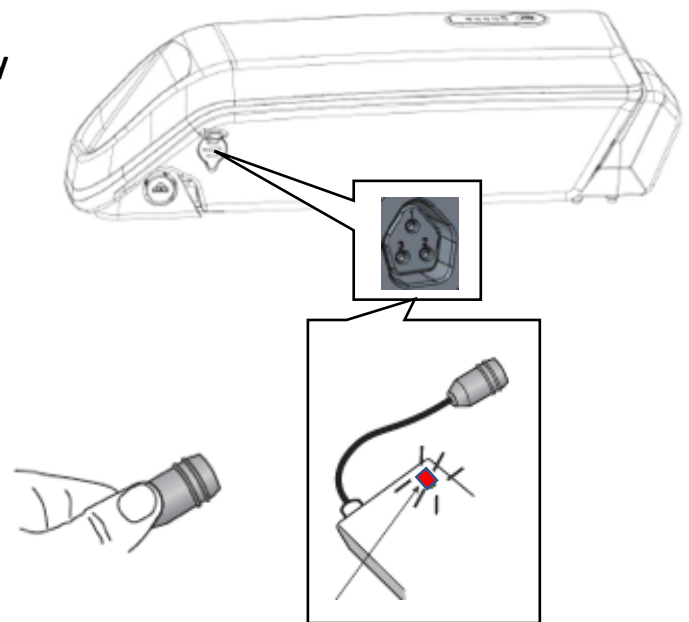

RED

The charger LED will change to RED while the battery is being charged.

Battery charging indication

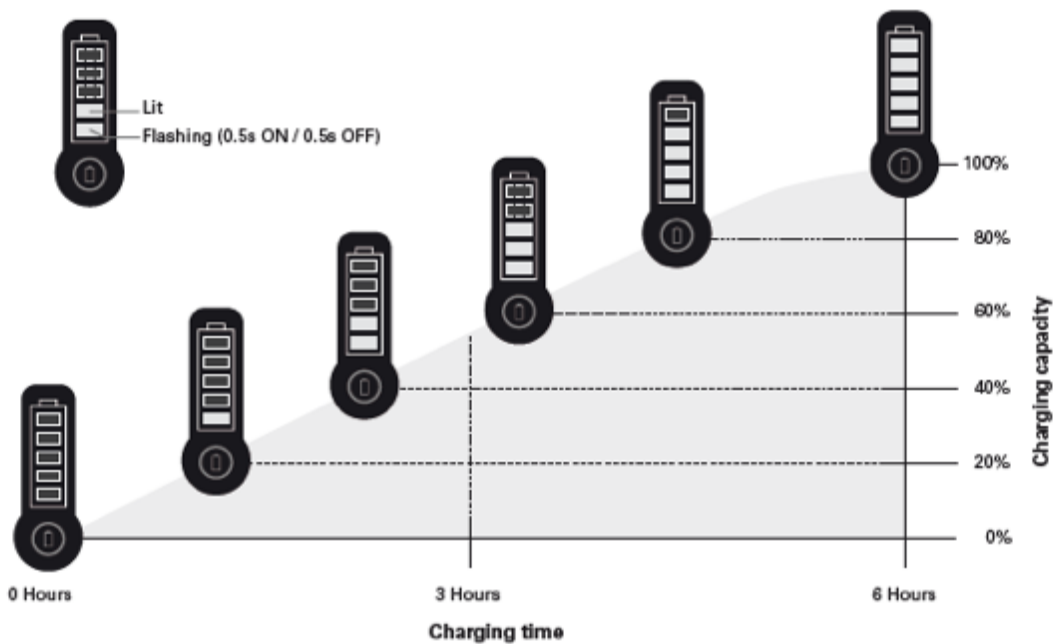

It is suggested to perform a complete discharge and recharge at every 3 months or after using 40 charging cycles in order to make the battery life longer.

Charging battery

On the bike

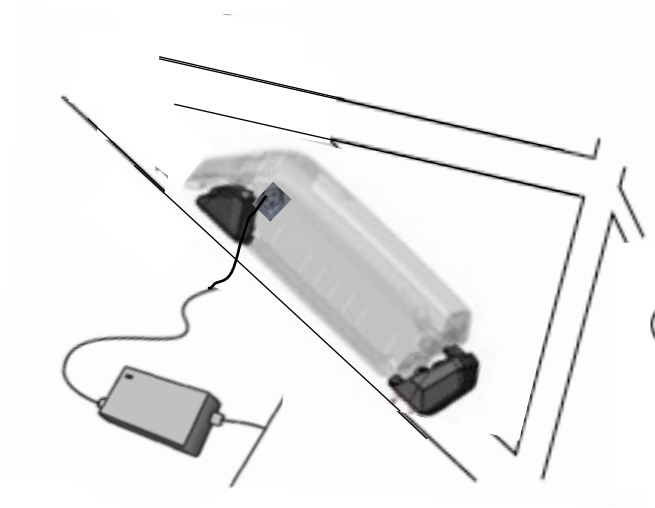



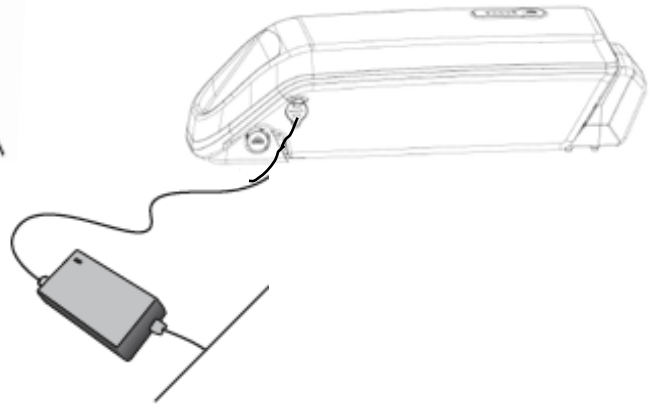

Off the bike



Battery state of health (SOH)

Press the battery power button for 5 seconds. One of the following patterns of the LEDs will be displayed showing the remaining capacity of the battery - Battery State Of Health (SOH).

Flashing for 10 seconds					
SOH remaining capacity	<80%	80-70%	70-80%	80-90%	>90%
Action	If <2 years old, battery replacement	N/A	N/A	N/A	N/A

Inserting the battery

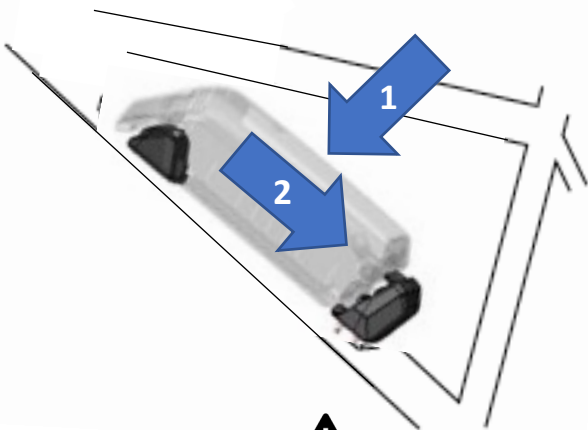

The battery must be inserted until hearing the “click” sound.

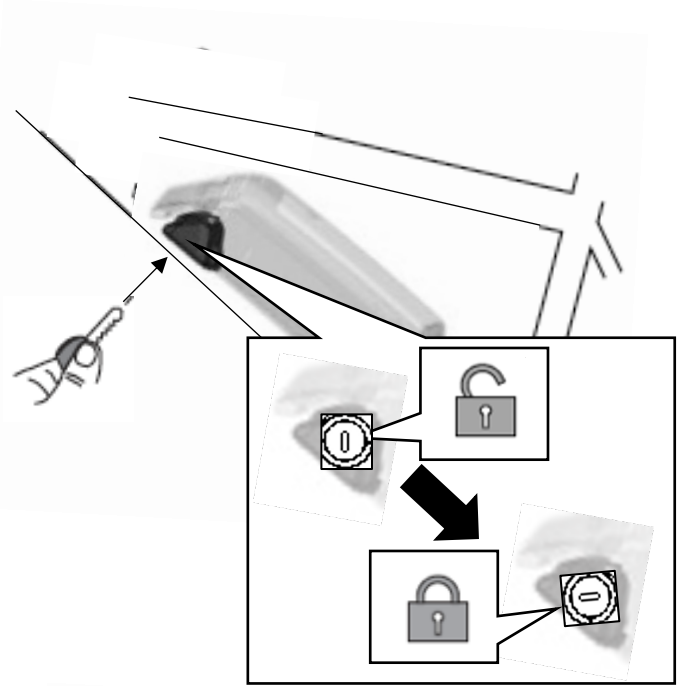

Removing the battery

I/O

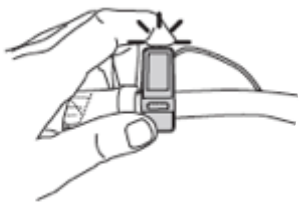

Switch off the system before removing the battery.



The number located on the battery key is required when purchasing replacement keys. Write it down in the box below and store it in a safe place.

Key number

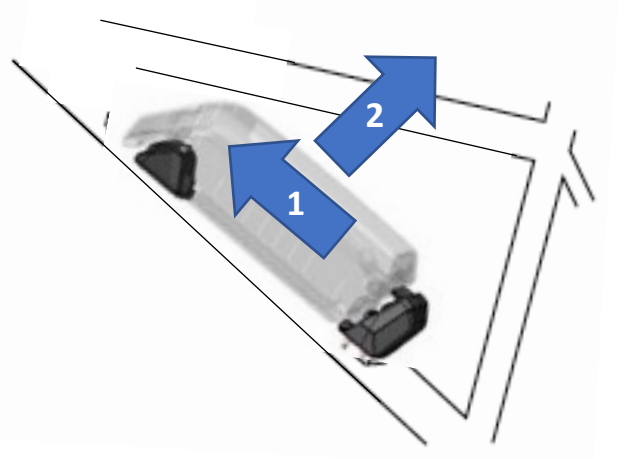
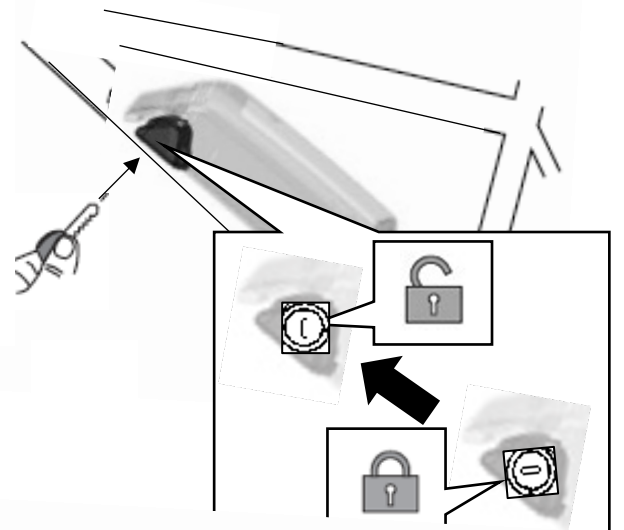

Switching the system on

1

Insert the battery and push the battery ON/OFF button

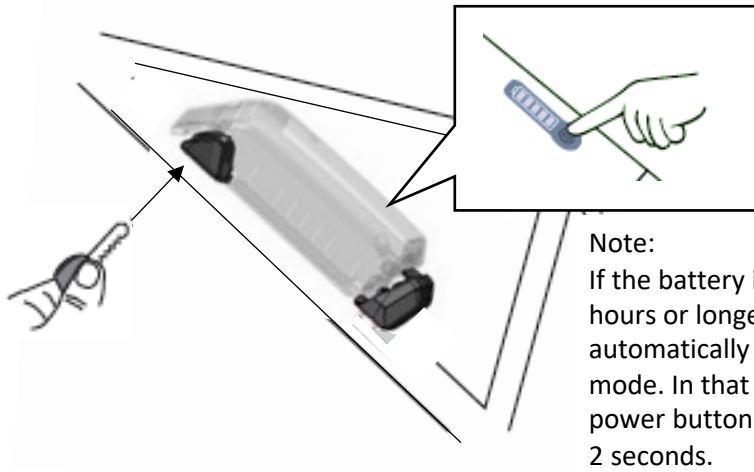

Note:
If the battery is not used for 2 hours or longer, it will automatically go into deep sleep mode. In that case, press the power button on the battery for 2 seconds.

2

Press power button on display

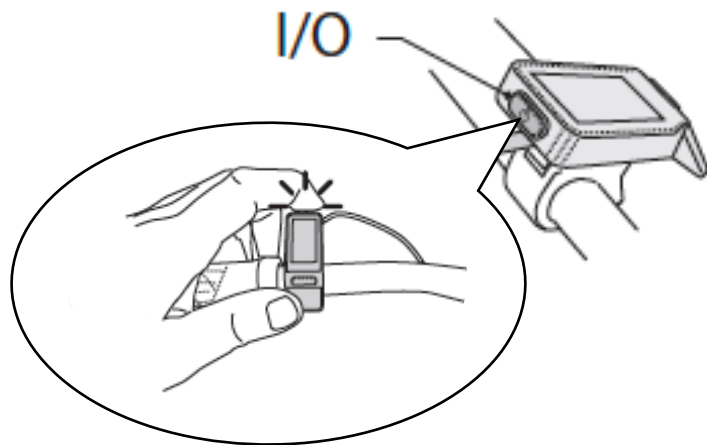

3

Select mode

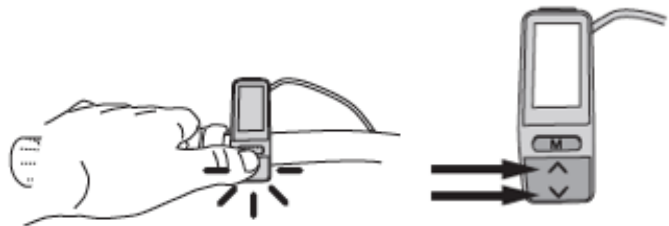

4

Start pedaling

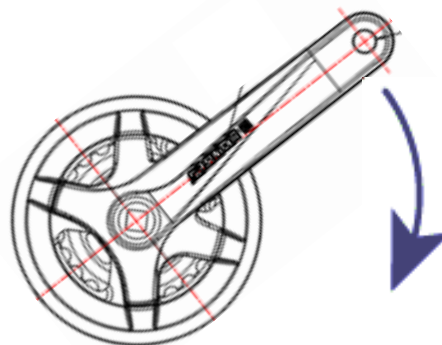

OLED remote display

Suggestion for mounting and key functions

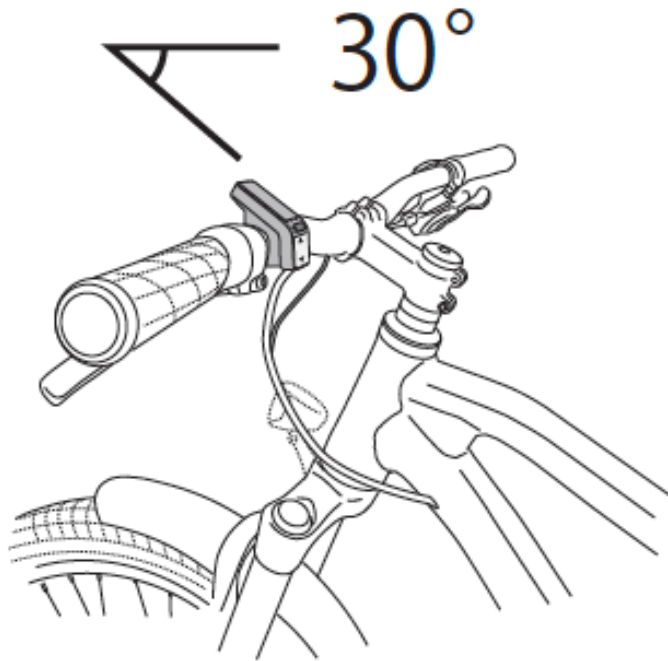

How the system to be switched on

Main switch:
On/Off

Info switch

Mode switch
(up/down)



Main switch:
On/Off

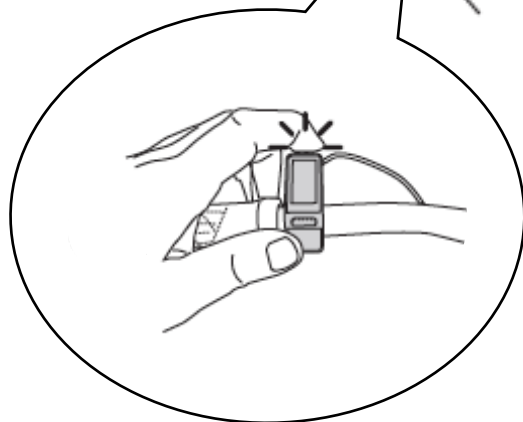
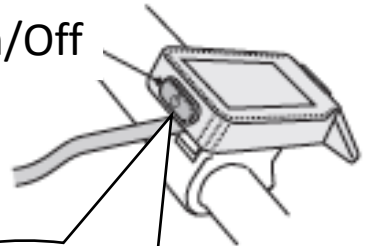

The SR SUNTOUR logo shows for 2 seconds when the system turns on.

Switching the system OFF

➤ **Switching OFF**

Press power button
on display for 0.5
seconds

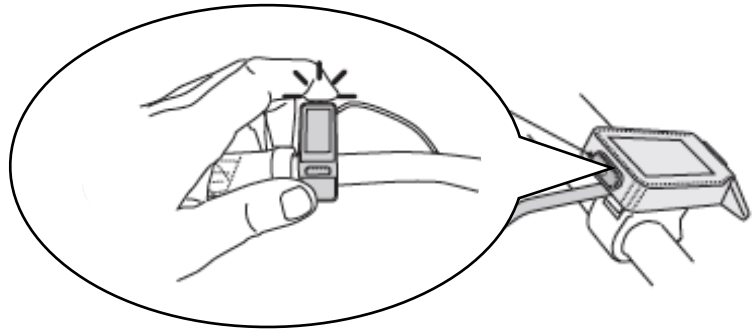

➤ **Automatic switching OFF**

System is automatically switched
off in 5 minutes of non-use.



OLED display base function

1. Base screen design

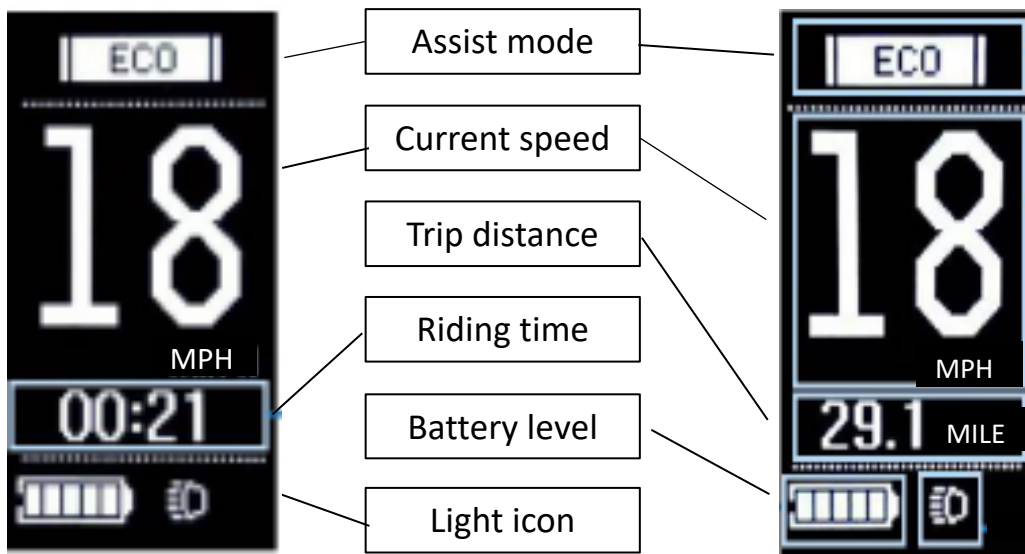

2. Clearing the trip distance, trip time, average speed and max. speed

After making sure that the system is not running, and after display turned on more than 10 seconds, press the “M” button for 2 seconds. Then the display goes into the data clean screen. After that, press “M” button short, then the confirmation window shows up, then press ^ or v button to select “YES” or “NO”. If “YES” is selected, the values of trip distance, trip time, average speed and max. speed becomes 0 and the screen returns to the default.

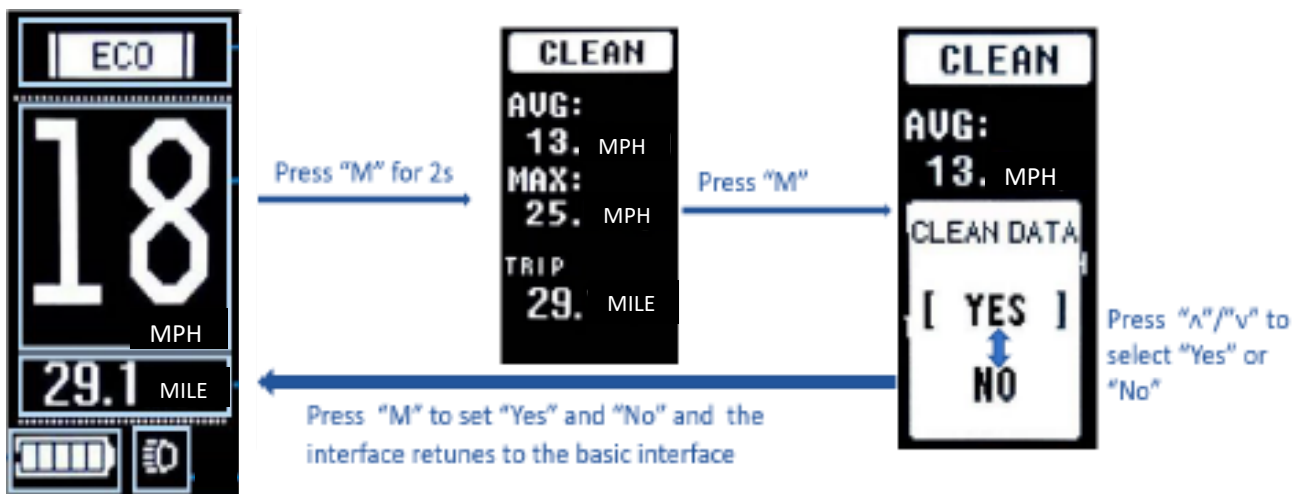

3. Display for changing assist mode



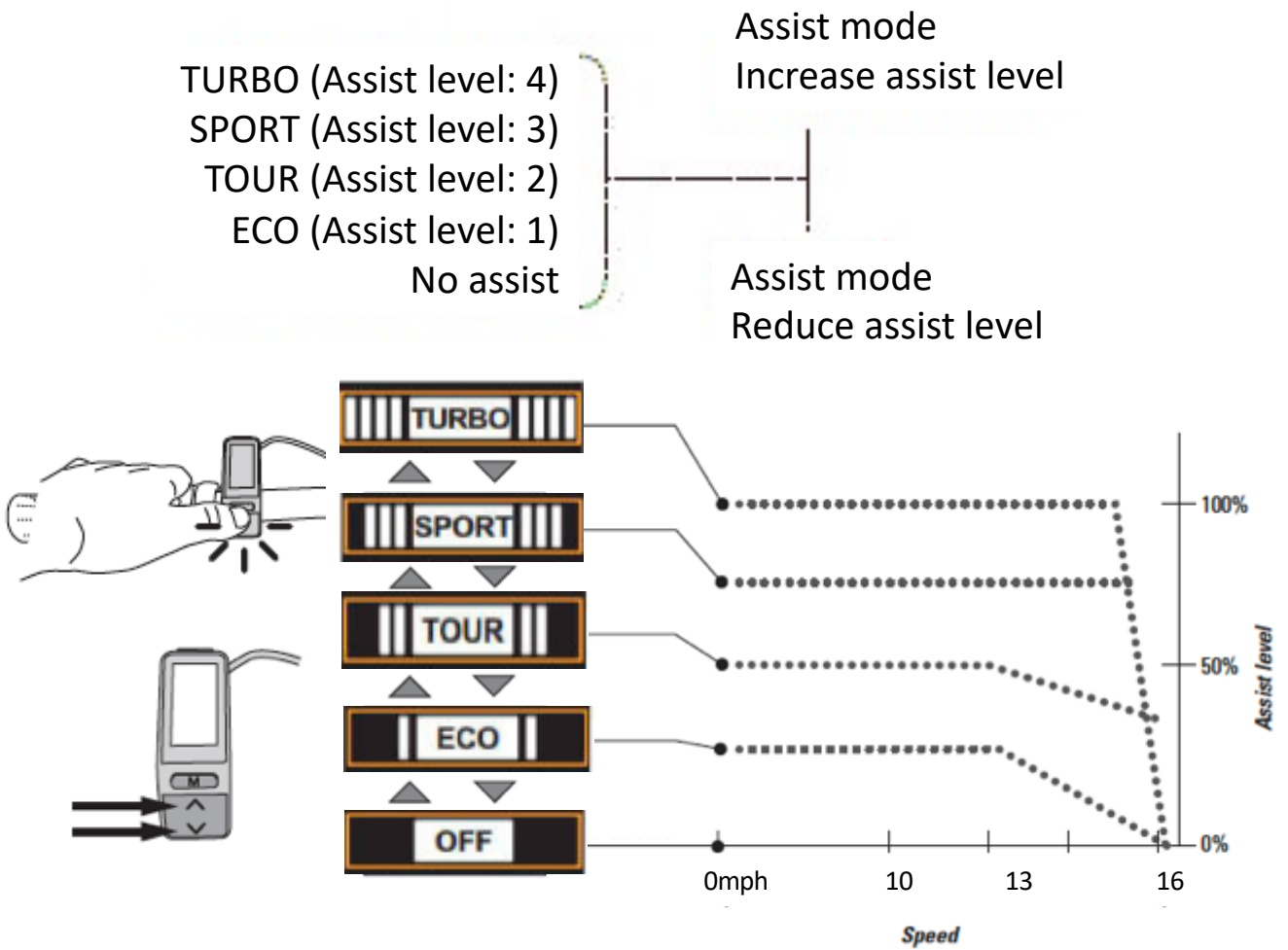











The assist level can be changed at any time by pushing \wedge or \vee button even while pedaling.





4. Battery state of charge (SOC)

LED indication on the battery pack

Press the button for a few seconds, then the LED lamps will be displayed as shown here.

		
 		0% (Blink 200ms/cycle)
 		9% – 1% (Blink 1s/cycle)
 		19% – 10%
 		39% – 20%
 		59% – 40%
 		79% – 60%
		100% – 80%

 Lighting
  No lighting
  Blinking

Note:

When the battery charge level becomes less than 5%. The output power will be reduced.

5. Range

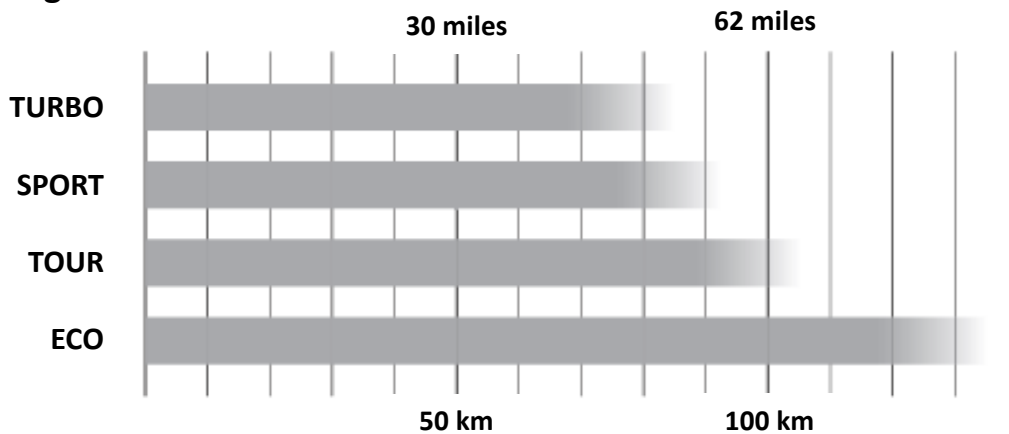

Factors which affect the range

The above figures are based on a speed of 12.5mph or 20 km/h on a level road at 15°C–20°C. The range is influenced by many factors:

- Weight of the rider
- Weight of the luggage
- Selection of path
- Pedaling behavior of the rider
- State of maintenance of the E-Bike
- Tire condition and air pressure in the tires
- Road condition (up & down)
- Speed, average speed and changes in speed
- Traffic flow, for example, stop and go
- Wind direction and wind speed

For information on using the battery, see pages 7-9 and 14-15. You'll also find information on how to maintain capacity and extend duration.

6. Changing information

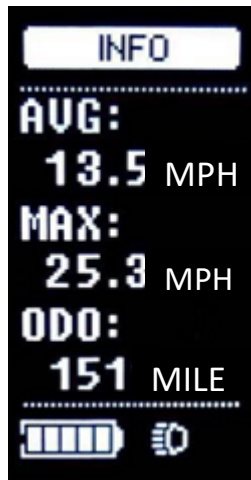
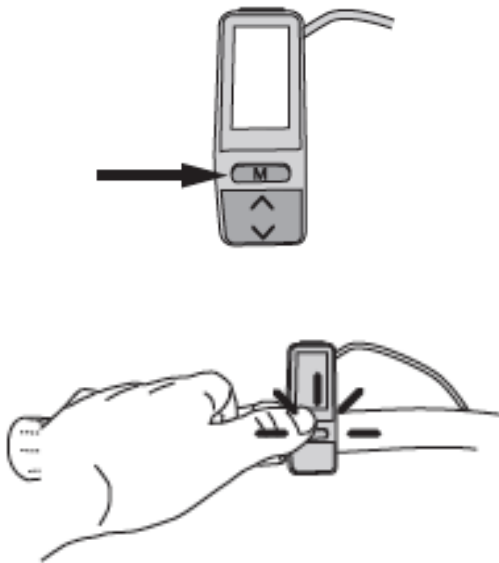

1st press "INFO"

- AVG: Average speed
- MAX: Max speed
- ODO: Total distance

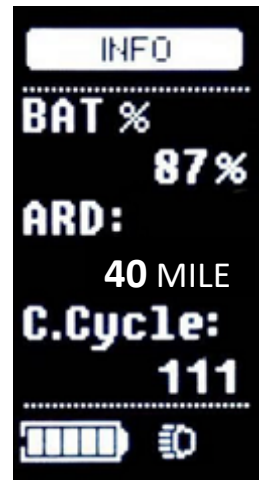



2nd press "INFO"

- Battery capacity: %
- ARD: remaining rideable distance
- Charging cycle

7. Walk assist function

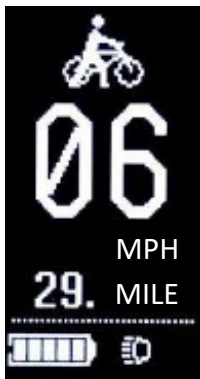
Keep pushing the  button for 2 seconds in order to activate the walk assist function, and release it to exit the walk assist function.



Walk assist icon shows up while pushing the  button

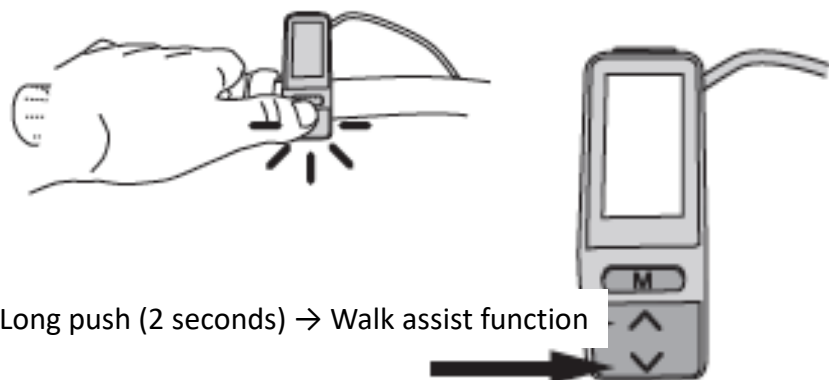

Long push (2 seconds) → Walk assist function

8. Head light and tail light (if applicable)

Keep pushing the \wedge button for 2 seconds in order to activate the light function “on” or “off”.

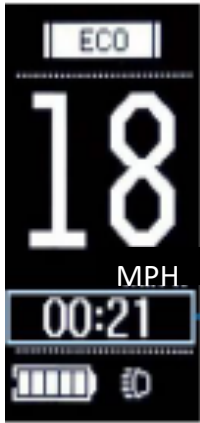

Light icon shows up when the lights are on

Long push (2 seconds) \rightarrow Light on/off

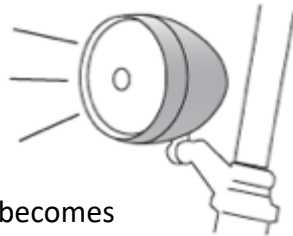
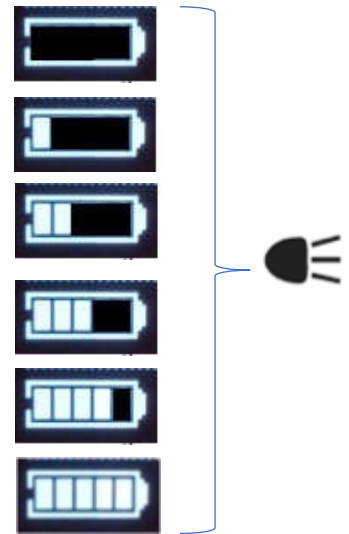
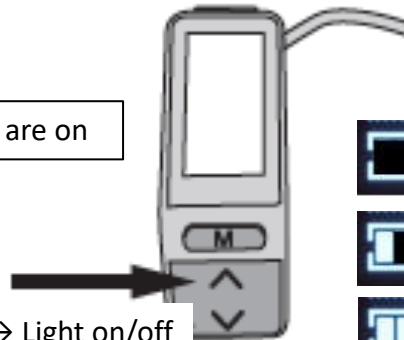

Note: Even if the battery becomes empty, there is some power for the light.

9. Heat monitoring function



The system is always monitoring the temperature during usage.

When the internal temperature reaches a certain value, the assist level gets gradually decreased and the speed indication starts blinking.

This is not a malfunction but prevent the internals from damage. When the temperatures returns to normal value, the blinking stops and assist shall be back to the normal level.

To remove the rear wheel

1. Cut the cable ties holding the waterproof motor cable connector under the non-drive side chain stay. Dis-connect the two halves of the connector. This requires some 'wiggling' of the connector to overcome the sealing.

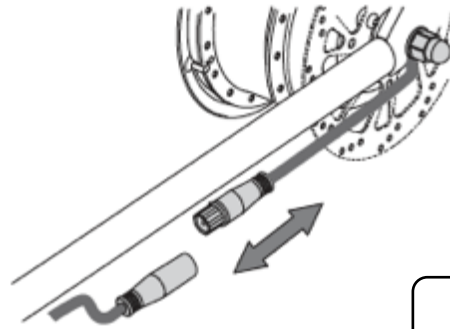

2. Loosen the motor fixing nuts by turning counter-clockwise, using a 15 mm spanner, then remove the wheel.

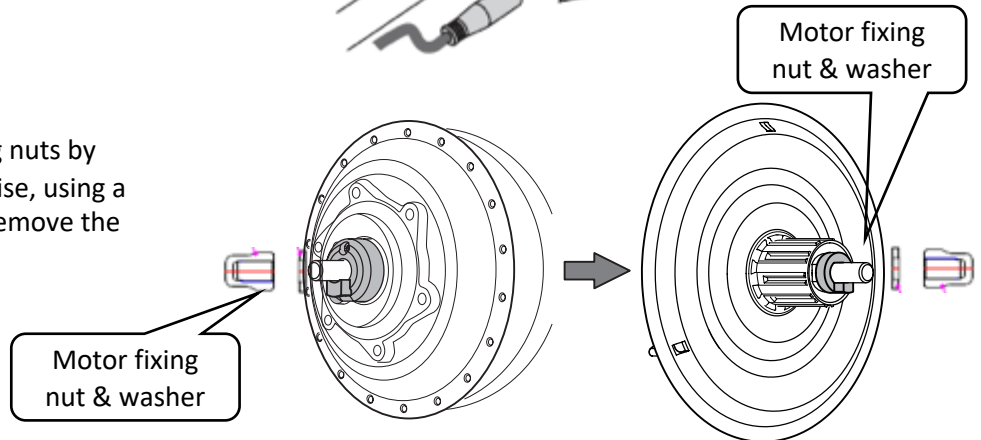

To re-insert the rear wheel

3. When refitting the wheel, ensure that the motor stopper from the motor to fit to the motor stopper from the frame, then slide the axle into the rear dropout slots.
4. Put the washers to the motor axle, then tighten the motor fixing nuts properly. Suggested tightening torque is 40-45 Nm.

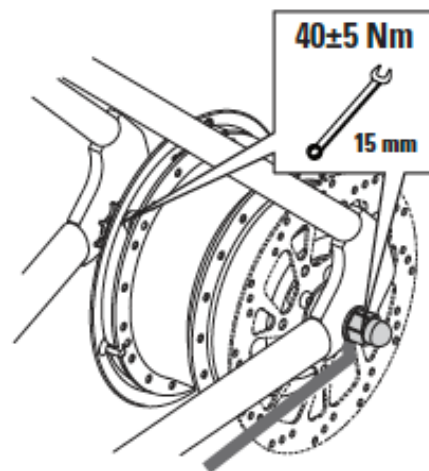

5. Reconnect the two halves of the motor connector, making sure that the arrows on both sides of connectors are aligned.
6. Keep pushing both connectors until feeling the click. Replace the zip-ties to secure the motor cable underneath the non-drive side of chain stay.

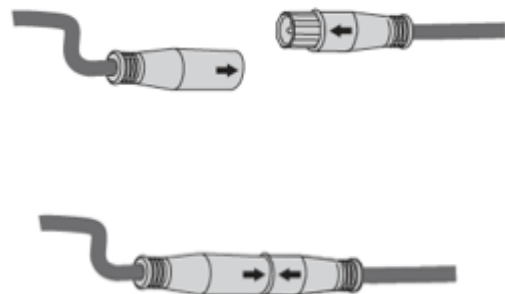

Error codes



SR SUNTOUR HESC system has a simple diagnostic function. In case if an error code message code will appear in the display window, turn the system completely off and then on. If the error message still appears, contact your local dealer for further assistance.



Error code shows up

Error code list				
Error Code	Error types	Problem Description	Trouble shooting	If problem still exists
<u>Controller</u>				
E00	No communication	Controller communication problem	Check the display connects to display cable, then power-on again	Replace controller or display or display cable
E01	Over current & over heat	Wrong function with driver IC	Turn off the system, let the controller cool down and re-start the system	Replace controller
E04	Short for light cable	Bike lightning system	Check the lighting system of the bike	Replace lighting system or controller
E05	Flash ROM initialization error	Controller Data failure	Remove the battery for 30 seconds, re-mount, then power-on again	Replace controller
<u>Sensor</u>				
E21	Irregular out-put voltage or no connection	Torque Sensor electrical problem	Check the sensor cable contacts	Replace the sensor
E22	Mechanical problem	Torque Sensor mechanical problem	Check the torque sensor mechanism for any problems	Replace the sensor
<u>Battery</u>				
E31	Battery error	Battery electric current sensor error	Remove the battery for 30 seconds, re-mount, then power-on again	Replace the controller
E32	Battery overcurrent error	Battery overcurrent error	Turn off the main switch and turn on	Replace the controller or battery
E33	Battery communication error	Battery communication error	Turn off the main switch and turn on	Replace the battery cable or battery
E34	Out of battery voltage range	Battery voltage error	Please check that the battery is dedicated to the system	Replace battery
E35	Battery overheat error	Battery over-temperature error	Remove the battery and let it cool down. after that, re-mount, then power-on again	Replace battery
<u>Motor</u>				
E41	Motor overheat	Motor overheating problem	Let the motor cool down	Replace motor or motor cable
E42	HALL sensor error or no connection	Motor Sensor failure	Check the motor-cable contacts to the motor	Replace the motor if it doesn't solve this error
E43	Speed sensor error (cannot detect speed)	Speed sensor failure	Check the magnet sensor in the motor shell	Replace the motor

Customer support office (Europe)		
Company	SR SUNTOUR EUROPE GmbH	SR SUNTOUR Düsseldorf GmbH
	Sales, Customer support and technical services	Sales, Customer support and technical services
Address	Riedstrasse 31, 83627 Warngau Germany	Fichtenstrasse 115, 40233 Düsseldorf Germany
Tel	+49-(0)802-150-793-0	+49-(0)211-5426-8950
Fax	+49-(0)802-150-793-29	+49-(0)211-5423-4776
E-mail	service@srsuntour-cycling.com	